

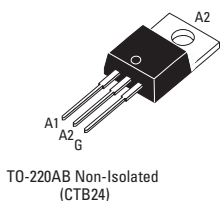

Applications

- Phase Control
- Static Switching
- Light Dimming
- Motor Speed Control
- Kitchen Equipment
- Power Tools
- Solenoid Valve Controls:
 - Dishwashers
 - Washing Machines

- Suitable for General Purpose AC Switching
- Alternistor/No Snubber Versions for Inductive Loads
- Logic Level Available for Use with Microcontrollers and Low Level Devices
- IGT Range 35-50 mA (Q1)
- V_{DRM}/V_{RMM} 400, 600, 800, 1000V

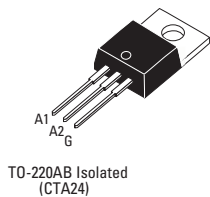

Absolute Maximum Ratings

	CONDITIONS	SYMBOL	RATING
RMS On-State Current (full sine wave)	$T_c = 100^\circ\text{C}$ $T_c = 75^\circ\text{C}$	TO-220AB TO-220AB Iso $I_{T(RMS)}$	25A
Non Repetitive Surge Peak On-State Current (Full Cycle, T_j Initial = 25°C)	F = 50 Hz F = 60 Hz	I_{TSM}	250A 260A
I^2t Value for fusing	$t_p = 10$ ms	I^2t	340A ² s
Critical rate of rise of on-state current $I_G = 2 \times I_{GT}$, $t_r < 100$ ns, $T_j = 125^\circ\text{C}$	F = 120 Hz	di/dt	100A/ μ s
Peak Gate Current @ $T_j = 125^\circ\text{C}$	$t_p = 20$ μ s	I_{GM}	4A
Average Gate Power Dissipation @ $T_j = 125^\circ\text{C}$		$P_{G(AV)}$	1W
Storage Temperature Range		Tstg	-40 to +150°C
Operating Junction Temperature Range		T_j	-40 to +125°C
Isolation Voltage (CTA Series only)		V_{ISO}	2500 V_{RMS}

Electrical Characteristics

ALTERNISTOR/NO SNUBBER AND LOGIC LEVEL (3 Quadrants)

		CW	BW
I_{GT} MAX @ $V_D = 12$ V, $R_L = 30\Omega$ NOTE 1	QI-II-III	35mA	50mA
V_{GT} MAX @ $V_D = 12$ V, $R_L = 30\Omega$	QI-II-III	1.3V	1.3V
V_{GD} MIN @ $V_D = V_{DRM}$, $R_L = 3.3k\Omega$	QI-II-III	0.2V	0.2V
I_H MAX @ $I_T = 500$ mA NOTE 2		50mA	75mA
I_L MAX @ $I_G = 1.2 I_{GT}$	QI-III	50mA	70mA
I_L MAX @ $I_G = 1.2 I_{GT}$	Q-II	80mA	100mA
dv/dt MIN @ $V_D = 67\%V_{DRM}$ (gate open) NOTE 2	$T_j = 125^\circ\text{C}$	500V/ μ s	1000V/ μ s
(di/dt)c MIN without Snubber NOTE 2 & 4	$T_j = 125^\circ\text{C}$	13A/ms	22A/ms

STANDARD (4 Quadrants)

		B
I_{GT} MAX @ $V_D = 12$ V, $R_L = 30\Omega$ NOTE 1	QI-II-III	50mA
I_{GT} MAX @ $V_D = 12$ V, $R_L = 30\Omega$ NOTE 1	QIV	100mA
V_{GT} MAX @ $V_D = 12$ V, $R_L = 30\Omega$	Q-AII	1.3V
V_{GD} MIN @ $V_D = V_{DRM}$, $R_L = 3.3k\Omega$	Q-AII	0.2V
I_H MAX @ $I_T = 500$ mA NOTE 2		80mA
I_L MAX @ $I_G = 1.2 I_{GT}$	QI-III-IV	70mA
I_L MAX @ $I_G = 1.2 I_{GT}$	Q-II	160mA
dv/dt MIN @ $V_D = 67\%V_{DRM}$ (gate open) NOTE 2	$T_j = 125^\circ\text{C}$	500V/ μ s
(dv/dt)c MIN @ (di/dt)c = 13.3 A/ms NOTE 2	$T_j = 125^\circ\text{C}$	10V/ μ s

GENERAL NOTES

1. Minimum IGT is guaranteed at 5% of IGT max.
2. For both polarities of A2 referenced to A1
3. All parameters at 25 degrees C unless otherwise specified.
4. Commutating dv/dt=50V. μ sec (exponential to 200Vpk)

Static Characteristics

$V_{T\text{ MAX @ } I_{T\text{M}} = 35\text{ A, } t_p = 380\mu\text{s}}$ NOTE 2	$T_j = 25^\circ\text{C}$	1.55V
$V_{T0\text{ MAX @ Threshold Voltage}}$ NOTE 2	$T_j = 125^\circ\text{C}$	0.85V
$R_{d\text{ MAX @ Dynamic Resistance}}$ NOTE 2	$T_j = 125^\circ\text{C}$	16mΩ
$I_{DRM\text{ MAX @ } V_{DRM} = V_{RRM}}$	$T_j = 25^\circ\text{C}$	5μA
$I_{RRM\text{ MAX @ } V_{DRM} = V_{RRM}}$	$T_j = 125^\circ\text{C}$	3mA

Thermal Resistances

	SYMBOL	RATING
Junction to Case (AC)	TO-220AB	$R_{th(j-c)}$ 0.8°C/W
Junction to Case (AC)	TO-220AB Isolated	$R_{th(j-c)}$ 1.7°C/W
Junction to Ambient	TO-220AB	$R_{th(j-a)}$ 60°C/W
Junction to Ambient	TO-220AB Isolated	$R_{th(j-a)}$ 60°C/W

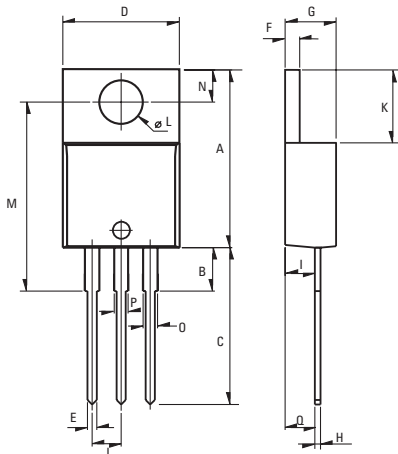

Weight: 2.3g (0.08 oz)

Dimensions

REF.	Millimeters			Inches		
	Min.	Typ.	Max.	Min.	Typ.	Max.
A	15.24		15.75	0.6		0.62
B		3.23			0.127	
C	12.78		13.79	0.503		0.543
D	9.96		10.36	0.392		0.408
E	0.69		0.94	0.027		0.037
F	1.22		1.32	0.048		0.052
G	4.62		4.83	0.182		0.19
H	0.46		0.61	0.018		0.024
I	2.49		2.84	0.098		0.112
J	2.39		2.69	0.094		0.106
K	6.48		6.88	0.255		0.271
L	3.78		3.89	0.149		0.153
M	15.49	16	16.51	0.61	0.63	0.65
N	2.59		2.9	0.102		0.114
O	0.99		1.55	0.039		0.061
P	0.99		1.55	0.039		0.061
Q		2.67			0.105	

Part Number Selection

Part Number	Voltage [Vpk]	I_{GT} [mA]	Type	Package
CTA/CTB24-xxxB	400, 600, 800, 1000	50mA	Standard	TO-220AB
CTA/CTB24-xxxBW	400, 600, 800, 1000	50mA	Alternistor/No Snubber	TO-220AB
CTA/CTB24-xxxCW	400, 600, 800, 1000	35mA	Alternistor/No Snubber	TO-220AB

Part Number Designation

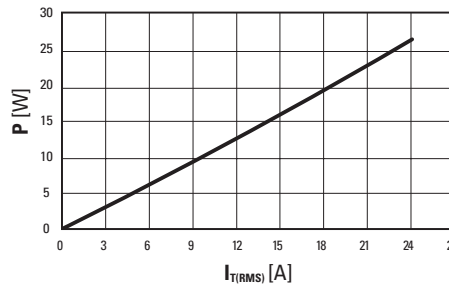
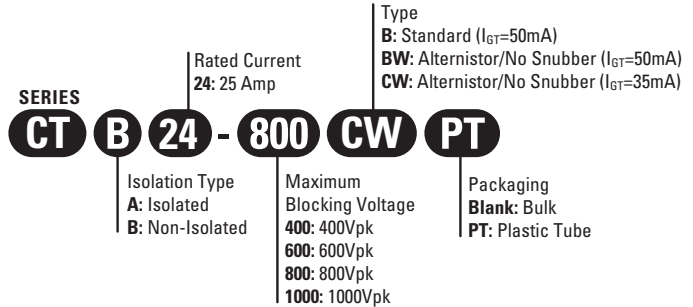

Fig. 1: Power dissipation versus RMS on-state current (full cycle).

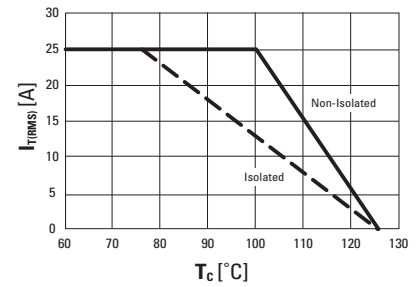

Fig. 2: RMS on-state current versus case temperature (full cycle)

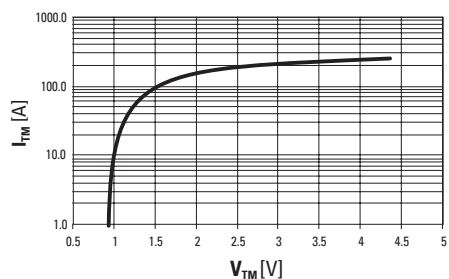

Fig. 3: On-state current versus on-state voltage (instantaneous values)

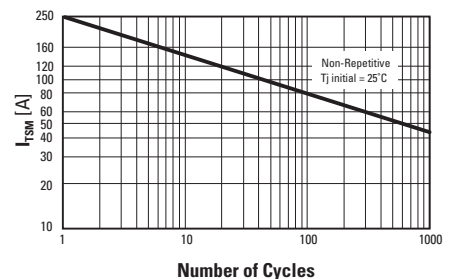

Fig. 4: Non-repetitive surge peak on-state current versus number of cycles.

ISO9001 CERTIFIED

Approvals

UL Recognized Component - E72445 (CTA Series)

USA

Sales & Tech Support (866) 258-5057
 Email: sales@cynergy3.com

Cynergy3 Components
 2320 Paseo de las Americas, Suite 104
 San Diego, CA 92154

EUROPE - UK

Telephone +44 (0) 1202 897969
 Fax +44 (0) 1202 891918

Email: sales@cynergy3.com
 Cynergy3 Components Ltd.
 7 Cobham Road
 Ferndown Industrial Estate
 Wimborne, Dorset BH21 7PE

ASIA - Thailand

Telephone +66 (0)2 665 2517
 Fax +66 (0)2 665 2588

Cynergy 3 Components, Asia
 18/8 Fico Place 12th Floor
 Soi Sukhumvit 21 (Asoke)
 Klongtoey Nua, Wattana
 Bangkok, Thailand 10110